

RACORD

DIN 11850

SOLDAR // MANDRINAR



Aisi 304L y Aisi 316L

NW: 10, 15, 20, 25, 32, 40, 50, 65, 80, 100, 125, 150

TUERCA

DIN 11850



Aisi 304L y Aisi 316L

NW: 10, 15, 20, 25, 32, 40, 50, 65, 80, 100, 125, 150

MACHO

DIN 11850

MANDRINAR
REF. 1001SOLDAR
REF. 1011

Ref. 1001



Ref. 1011

Aisi 304L y Aisi 316L

NW: 10, 15, 20, 25, 32, 40, 50, 65, 80, 100, 125, 150

CASQUILLO

DIN 11850

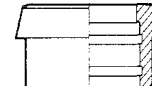
MANDRINAR
REF. 1002SOLDAR
REF. 1012

Ref. 1002

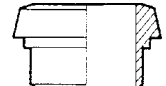

Ref. 1012

Aisi 304L y Aisi 316L

NW: 10, 15, 20, 25, 32, 40, 50, 65, 80, 100, 125, 150

JUNTA RACORD

DIN 11850

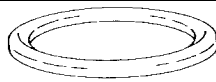

	NBR	MVQ	EPDM	VITON	PTFE
REF	1007	1004	1005	1006	1010

NW: 10, 15, 20, 25, 32, 40, 50, 65, 80, 100, 125, 150

TUERCA CIEGA

DIN 11850

REF. 1023

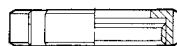

Aisi 304L y Aisi 316L

NW: 10, 15, 20, 25, 32, 40, 50, 65, 80, 100, 125, 150

TUERCA CIEGA CON PIVOTE

DIN 11850

REF. 1024



Aisi 304L y Aisi 316L

NW: 10, 15, 20, 25, 32, 40, 50, 65, 80, 100, 125, 150

TUERCA CIEGA COMPLETA

DIN 11850

REF. 1025



Aisi 304L y Aisi 316L

NW: 10, 15, 20, 25, 32, 40, 50, 65, 80, 100, 125, 150

CADENA Y LLAVE

DIN 11850

REF. 1027

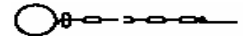

REF. 8500



Aisi 304L y Aisi 316L

NW: 10, 15, 20, 25, 32, 40, 50, 65, 80, 100, 125, 150

JUNTA PLANA

DIN 11850



	NBR	MVQ	VITON
REF	1029	1026	1028

NW: 10, 15, 20, 25, 32, 40, 50, 65, 80, 100, 125, 150

LLAVE

DIN 11850

A.304L



TD 018-009



NW: 10, 15, 20, 25, 32, 40, 50, 65, 80, 100, 125, 150

MANGUITO MANGUERA

DIN 11850

SOLDAR

REF. 1100



Aisi 304L y Aisi 316L

NW: 10, 15, 20, 25, 32, 40, 50, 65, 80, 100

MANGUITO MANGUERA TUBO

DIN 11850

SOLDAR

REF. 1110

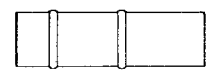

Aisi 304L y Aisi 316L

NW: 10, 15, 20, 25, 32, 40, 50, 65, 80, 100

MANGUITO MANGUERA MACHO REF. 1101
DIN 11850

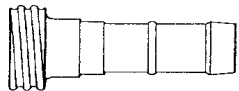

Aisi 304L y Aisi 316L

NW: 10, 15, 20, 25, 32, 40, 50, 65, 80, 100

MANG. MANGUERA MACHO TUBO REF. 1111
DIN 11850

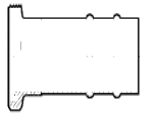

Aisi 304L y Aisi 316L

NW: 10, 15, 20, 25, 32, 40, 50, 65, 80, 100

MANG. MANGUERA CASQUILLO REF. 1102
DIN 11850

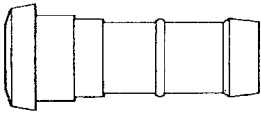

NW: 10, 15, 20, 25, 32, 40, 50, 65, 80, 100

MANG. MANGUERA CASQUILLO TUBO REF. 1112
DIN 11850

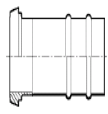

Aisi 304L y Aisi 316L

NW: 10, 15, 20, 25, 32, 40, 50, 65, 80, 100

MACHO DIN-GAS REF. 1801
ROSCA EXTERIOR
DIN 11850

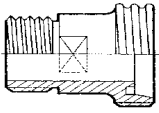

Aisi 304L

NW: 10, 15, 20, 25, 32, 40, 50, 65, 80, 100

CASQUILLO DIN-GAS REF. 1802
ROSCA EXTERIOR
DIN 11850

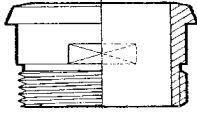

Aisi 304L

NW: 10, 15, 20, 25, 32, 40, 50, 65, 80, 100

TUERCA DIN-GAS REF. 1811
ROSCA INTERIOR
DIN 11850

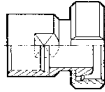

Aisi 304L

NW: 10, 15, 20, 25, 32, 40, 50, 65, 80, 100

MACHO DIN-GAS REF. 1812
ROSCA INTERIOR
DIN 11850

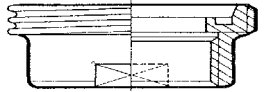

Aisi 304L

NW: 10, 15, 20, 25, 32, 40, 50, 65, 80, 100

ABRAZADERA Ref.8300
DIN 11850

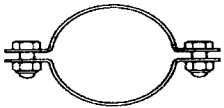

Aisi 304L

NW: 10, 15, 20, 25, 32, 40, 50, 65, 80, 100, 125, 150

MANGUITO FLEXIBLE Ref.8450
DIN 11850

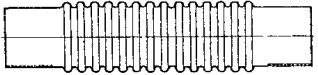

Aisi 304L

NW: 10, 15, 20, 25, 32, 40, 50, 65, 80, 100

REDUCCION CONCENTRICA SOLDAR Ref.1300
DIN 11850
Aisi 316L
MATE y PULIDO
INTERIOR / EXTERIOR



NW	15/10	20/15	25/15	25/20	32/20	32/25	40/20
	40/25	40/32	50/25	50/32	50/40	65/32	65/40
	65/50	80/40	80/40	80/50	80/65	100/50	100/65
	100/80						

REDUCCION EXCENTRICA Ref.1302
DIN 11850
Aisi 316L
MATE y PULIDO
INTERIOR / EXTERIOR

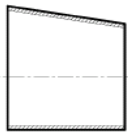

NW	15/10	20/15	25/15	25/20	32/20	32/25	40/20
	40/25	40/32	50/25	50/32	50/40	65/32	65/40
	65/50	80/40	80/40	80/50	80/65	100/50	100/65
	100/80						

REDUCCION CONCENTRICA

Ref.1311

Macho/Macho
 DIN 11850
 Aisi 304L y Aisi 316L
 PULIDO INTERIOR/EXTERIOR

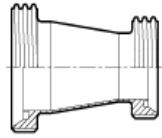

NW

32/25 40/25 40/32 50/32 50/40 65/40 65/50
 80/50 80/65 100/65 100/80

REDUCCION CONCENTRICA

Ref.1313

Macho /Tuerca
 DIN 11850
 Aisi 304L y Aisi 316L
 PULIDO INTERIOR/EXTERIOR

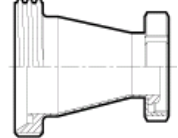

NW

32/25 40/25 40/32 50/32 50/40 65/40 65/50
 80/50 80/65 100/65 100/80

REDUCCION CONCENTRICA

Ref. 1331

Tuerca/Macho
 DIN 11850
 A.304L - A.316L
 PULIDO INTERIOR/EXTERIOR

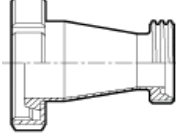

NW

32/25 40/25 40/32 50/32 50/40 65/40 65/50
 80/50 80/65 100/65 100/80

REDUCCION CONCENTRICA

Ref. 1333

Tuerca/Tuerca
 DIN 11850
 A.304L - A.316L
 PULIDO INTERIOR/EXTERIOR

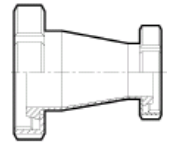

NW

32/25 40/25 40/32 50/32 50/40 65/40 65/50
 80/50 80/65 100/65 100/80

CODO 90° Soldar

Ref.2100

DIN 11850
 A.304L
 MATE y PULIDO
 INTERIOR / EXTERIOR

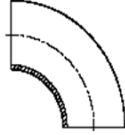

NW: 10, 15, 20, 25, 32, 40, 50, 65, 80, 100, 125, 150

CODO 90° Soldar

Ref.2100

DIN 11850
 A.316L
 MATE y PULIDO
 INTERIOR / EXTERIOR

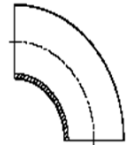

NW: 10, 15, 20, 25, 32, 40, 50, 65, 80, 100, 125, 150

CODO 90°

Ref.2111

Macho/Macho
 DIN 11850
 Aisi 304L y Aisi 316L
 PULIDO INTERIOR/EXTERIOR

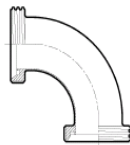

NW: 10, 15, 20, 25, 32, 40, 50, 65, 80, 100

CODO 90°

Ref.2113

Macho /Tuerca
 DIN 11850
 Aisi 304L y Aisi 316L
 PULIDO INTERIOR/EXTERIOR

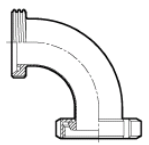

NW: 10, 15, 20, 25, 32, 40, 50, 65, 80, 100

CODO 90° Mandrinar

Ref.2000

DIN 11850
 Aisi 304L y Aisi 316L
 PULIDO INTERIOR/EXTERIOR

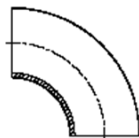

NW: 10, 15, 20, 25, 32, 40, 50, 65, 80, 100

CODO

Ref.2120

Casquillo /Soldar
 DIN 11850
 Aisi 304L y Aisi 316L
 PULIDO INTERIOR/EXTERIOR

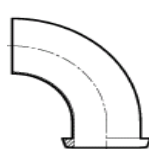

NW: 10, 15, 20, 25, 32, 40, 50, 65, 80, 100

CODO

Ref.2133

Tuerca/Tuerca
 DIN 11850
 Aisi 304L y Aisi 316L
 PULIDO INTERIOR/EXTERIOR

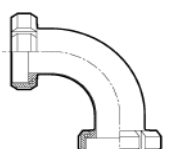

NW: 10, 15, 20, 25, 32, 40, 50, 65, 80, 100

CODO

Ref.2110

Macho/Soldar
 DIN 11850
 Aisi 304L y Aisi 316L
 PULIDO INTERIOR/EXTERIOR

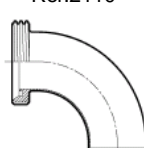

NW: 10, 15, 20, 25, 32, 40, 50, 65, 80, 100

CODO 45°

Ref.2200

Soldar
 DIN 11850
 Aisi 316L
 PULIDO INTERIOR/EXTERIOR



NW: 10, 15, 20, 25, 32, 40, 50, 65, 80, 100

CURVA 180°

Ref.2800

Soldar /Mandrinar
 DIN 11850
 Aisi 304L y Aisi 316L
 PULIDO INTERIOR/EXTERIOR



NW: 10, 15, 20, 25, 32, 40, 50, 65, 80, 100

CURVA 180°

Ref.2833

Tuerca/Tuerca
 DIN 11850
 Aisi 304L y Aisi 316L
 PULIDO INTERIOR/EXTERIOR

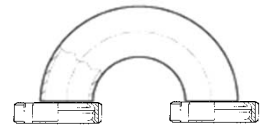

NW: 10, 15, 20, 25, 32, 40, 50, 65, 80, 100

TE

Ref.3000

Soldar /Mandrinar
 DIN 11850
 Aisi 304L y Aisi 316L
 MATE y PULIDO
 INTERIOR / EXTERIOR

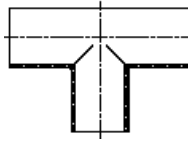

NW: 10, 15, 20, 25, 32, 40, 50, 65, 80, 100, 125, 150

TE CORTA

DIN 11850
 Aisi 316L
 MATE y PULIDO



NW: 10, 15, 20, 25, 32, 40, 50, 65, 80, 100, 125, 150

TE

Ref.3111

Macho/Macho/Macho
 DIN 11850
 Aisi 316L

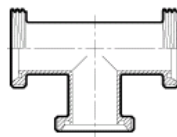

NW: 10, 15, 20, 25, 32, 40, 50, 65, 80, 100

TE

Ref.3333

Tuerca/Tuerca/Tuerca
 DIN 11850
 Aisi 316L

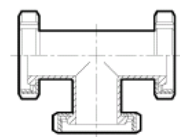

NW: 10, 15, 20, 25, 32, 40, 50, 65, 80, 100

TE CON 1 VALVULA M/M/M

Ref.4201

DIN 11850
 Aisi 304L y Aisi 316L

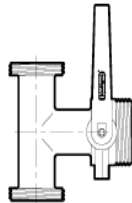

NW: 10, 15, 20, 25, 32, 40, 50, 65, 80, 100

TE CON 1 VALVULA M/M/M

Ref.4202

DIN 11850
 Aisi 304L y Aisi 316L

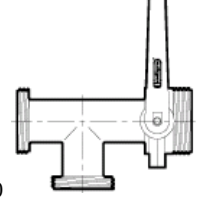

NW: 10, 15, 20, 25, 32, 40, 50, 65, 80, 100

TE CON 2 VALVULA M/M/M

Ref.4203

DIN 11850
 Aisi 304L y Aisi 316L

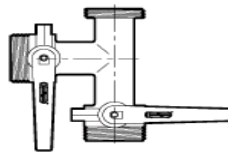

NW: 10, 15, 20, 25, 32, 40, 50, 65, 80, 100

TE CON 2 VALVULA M/M/M

Ref.4204

DIN 11850
 Aisi 304L y Aisi 316L

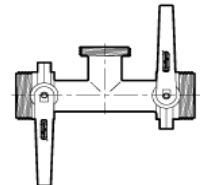

NW: 10, 15, 20, 25, 32, 40, 50, 65, 80, 100

TE CON 3 VALVULA M/M/M

Ref.4205

DIN 11850
 Aisi 304L y Aisi 316L

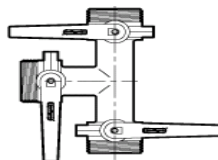

NW: 10, 15, 20, 25, 32, 40, 50, 65, 80, 100

CRUZ SOLDAR

Ref.30000

DIN 11850
 Aisi 316L

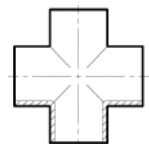

NW: 10, 15, 20, 25, 32, 40, 50, 65, 80, 100

VALVULA DE BOLA

Soldar / Soldar
Aisi 304L y Aisi 316L

Ref.6400

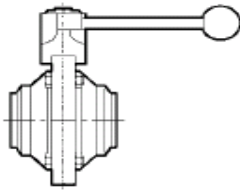

NW: 10, 15, 20, 25, 32, 40, 50, 65, 80, 100

VALVULA DE BOLA

Macho / Soldar
Aisi 304L y Aisi 316L

Ref.6410

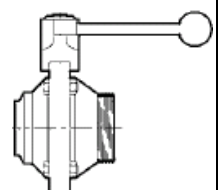

NW: 10, 15, 20, 25, 32, 40, 50, 65, 80, 100

VALVULA DE BOLA

Macho / Macho
Aisi 304L y Aisi 316L

Ref.6411

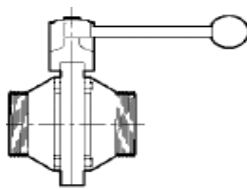

NW: 10, 15, 20, 25, 32, 40, 50, 65, 80, 100

GRIFO 3 VIAS

Macho / Macho
Aisi 304L y Aisi 316L

Ref.6111

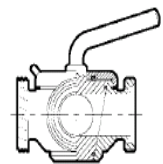

NW: 10, 15, 20, 25, 32, 40, 50, 65, 80, 100

VALVULA DE BOLA ENOLOGICA, ESFERA "SIEMPRE LLENA", PASO REDUCIDO

1 Macho/Macho
2 Macho/ Soldar
3 Soldar/ Soldar
Aisi 304L

NW: 40, 50, 65, 80

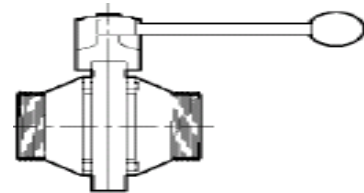
**VALVULA DE MARIPOSA**

Soldar / Soldar
DIN 11850
Aisi 304L y Aisi 316L

Ref.4000

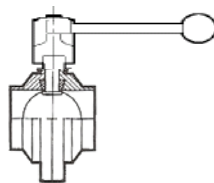

NW: 25, 32, 40, 50, 65, 80, 100, 125, 150

VALVULA DE MARIPOSA

Macho / Macho
DIN 11850
Aisi 304L y Aisi 316L

Ref.4011

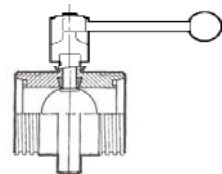

NW: 25, 32, 40, 50, 65, 80, 100, 125, 150

VALVULA DE MARIPOSA

Macho / Soldar
DIN 11850
Aisi 304L y Aisi 316L

Ref.4010

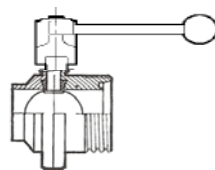

NW: 25, 32, 40, 50, 65, 80, 100, 125, 150

VALVULA DE MARIPOSA

Macho / Tuerca
DIN 11850
Aisi 304L y Aisi 316L

Ref.4013

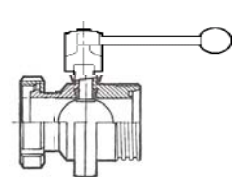

NW: 25, 32, 40, 50, 65, 80, 100, 125, 150

VALVULA DE MARIPOSA

Tuerca / Tuerca
DIN 11850
Aisi 304L y Aisi 316L

Ref.4033

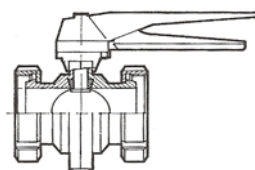

NW: 25, 32, 40, 50, 65, 80, 100

VALVULA DE MARIPOSA

Macho / Brida
DIN 11850
Aisi 304L y Aisi 316L

Ref.4019 PN 10

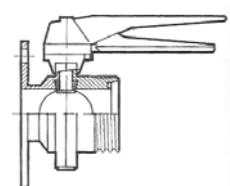

NW: 25, 32, 40, 50, 65, 80, 100

VALVULA DE MARIPOSA

Ref.4900

DIN 11850

Aisi 304L y Aisi 316L

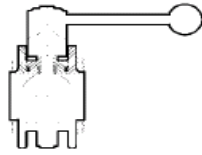

NW: 25, 32, 40, 50, 65, 80, 100, 125, 150

MANETA MULTIPOSICION

Ref.4800

DIN 11850

Aisi 316L

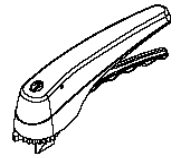

NW: 25, 32, 40, 50, 65, 80, 100

MANETA DOS POSICIONES

Ref.G84

DIN 11850

Aisi 304L

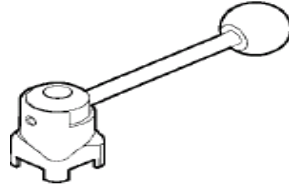

NW 25/50, 65/80, 100, 125, 150

MANETA DETECTOR PROXIMIDAD

Ref.4550

DIN 11850

Aisi 304L

DIN 11850

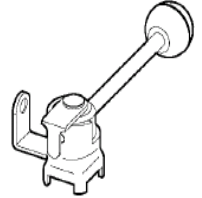

NW 25/65, 80, 100, 125, 150

MANETA MICROMETRICA

Ref.4802

DIN 11850

Aisi 304L



NW 25/65, 80, 100

SOPORTE ACTUADOR NEUMATICO

Ref.4200

DIN 11850

Aisi 304L

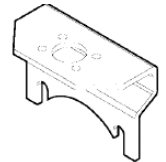

NW 25/100, 125/150

NEUMATICO SIMPLE EFECTO

Ref.4300

DIN 11850

Aisi 304L



NW 25/100, 125/150

NEUMATICO DOBLE EFECTO

Ref.4400

DIN 11850

Aisi 304L

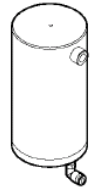

NW 25/100, 125/150

NEUMATICO SIMPLE EFECTO

Ref.4321

Aisi 304L



NW 25/100, 125/150

NEUMATICO DOBLE EFECTO

Ref.4422

Aisi 304L



NW 25/100, 125/150

CAPSULA THINK TOP S/EFECTO

Ref.4322 - 9564

**MARIPOSA**

Ref.98

Aisi 304L y Aisi 316L

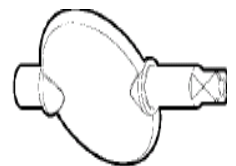

NW: 25, 32, 40, 50, 65, 80, 100, 125, 150

SOPORTE Y LEVA Ref.9566
 DETECTOR PROXIMIDAD
 Aisi 304L

DETECTOR DE PROXIMIDAD Ref.9567
 Aisi 304L



JUNTA VALVULA DE MARIPOSA
 DIN 11850

	SIL	EPDM	VITON	NBR
FIG:	4040	4042	4041	4043

NW
 25, 32, 40, 50, 65, 80, 100, 125, 150



VALVULA DE SOBREPRESION Ref.7400
 Soldar / Soldar
 DIN 11850
 Aisi 316L

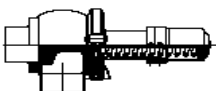

NW: 25, 32, 40, 50, 65, 80

VALVULA DE SOBREPRESION Ref.7411
 Macho / Macho
 DIN 11850
 Aisi 316L

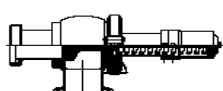

NW: 25, 32, 40, 50, 65, 80

VALVULA DE RETENCION Ref.7200
 Soldar / Soldar
 DIN 11850
 Aisi 316L

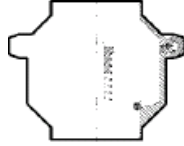

NW: 25, 32, 40, 50, 65, 80, 100

VALVULA DE RETENCION Ref.7212
 Macho / Soldar
 DIN 11850
 Aisi 316L

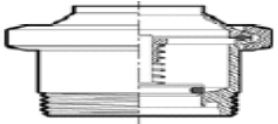

NW: 25, 32, 40, 50, 65, 80, 100

VALVULA DE REGULACION Ref.7800
 Soldar / Soldar
 DIN 11850
 Aisi 304L y Aisi 316L

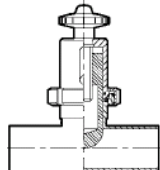

NW: 25, 32, 40, 50, 65, 80, 100

VALVULA DE HUSILLO Ref.7711
 Macho / Macho
 DIN 11850
 Aisi 316L

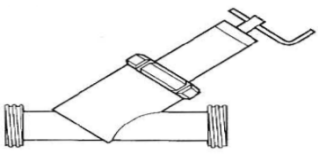

NW: 25, 32, 40, 50, 65

FILTRO RECTO Ref.8111
 Macho / Macho
 DIN 11850
 Aisi 316L



NW: 25, 32, 40, 50, 65, 80, 100

FILTRO ESCUADRA Ref.8211
 Macho / Macho
 DIN 11850
 Aisi 316L



NW: 25, 32, 40, 50, 65, 80, 100

TAMIZ FILTRO Ref.8199 Ref.8299
 RECTO Y ESCUADRA
 DIN 11850
 Aisi 316L
 AGUJERO ESTANDAR 10 x1 mm

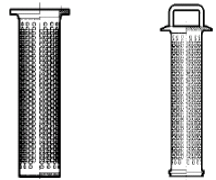

NW: 25, 32, 40, 50, 65, 80, 100

TAMIZ FILTRO Ref.8399
 RECTO CORTO
 DIN 11850
 Aisi 316L
 AGUJERO ESTANDAR 0,5 mm

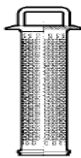

NW: 25, 32, 40, 50, 65, 80, 100

FILTRO RECTO CORTO

Macho / Macho
 DIN 11850
 Aisi 304L y Aisi 316L

Ref.8311

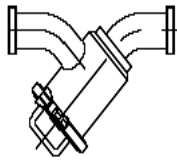

NW: 25, 32, 40, 50, 65, 80, 100

VALVULA PRESION-VACIO

DIN 11850
 Aisi 316L

Ref.7550

DN 2", 2 1/2"

**MIRILLA DOBLE**

DIN 11850
 Aisi 304L y Aisi 316L

Ref.8054

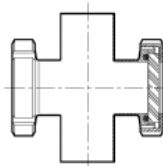

NW: 25, 32, 40, 50, 65, 80, 100

MIRILLA TUBULAR

Soldar / Soldar
 DIN 11850
 Aisi 316L

Ref.8000

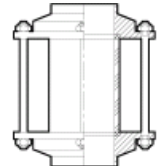

NW: 25, 32, 40, 50, 65, 80, 100, 125

MIRILLA TUBULAR

Macho / Soldar
 DIN 11850
 Aisi 316L

Ref.8010

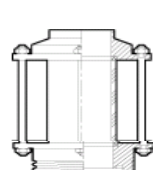

NW: 25, 32, 40, 50, 65, 80, 100, 125

MIRILLA TUBULAR

Macho / Macho
 DIN 11850
 Aisi 316L

Ref.8011

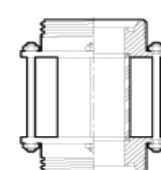

NW: 25, 32, 40, 50, 65, 80, 100, 125

MIRILLA TUBULAR

Macho / Tuerca
 DIN 11850
 Aisi 316L

Ref.8013

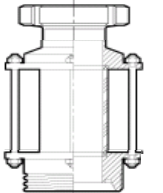

NW: 25, 32, 40, 50, 65, 80, 100, 125

MIRILLA TUBULAR

Tuerca / Tuerca
 DIN 11850
 Aisi 316L

Ref.8033

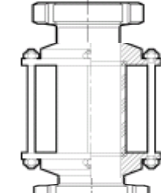

NW: 25, 32, 40, 50, 65, 80, 100, 125

VIDRIO MIRILLA TUBULAR

DIN 11850
 PIREX

Ref.8040



NW: 25, 32, 40, 50, 65, 80, 100, 125, 150

JUNTA MIRILLA TUBULAR

DIN 11850
 SILICONA

Ref.8041

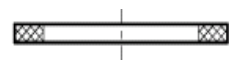

NW: 25, 32, 40, 50, 65, 80, 100, 125, 150

PROTECCION VIDRIO

DIN 11850
 Aisi 304L

Ref.8042

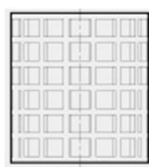

NW: 25, 32, 40, 50, 65, 80, 100, 125, 150

MIRILLA PLANA

DIN 11850
 Aisi 304L y Aisi 316L

Ref.8050

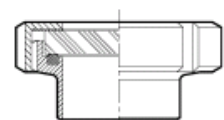

NW: 25, 32, 40, 50, 65, 80, 100, 125, 150

VIDRIO MIRILLA PLANA

DIN 11850

PIREX Ref.8051
 TEMP Ref.8055



NW: 25, 32, 40, 50, 65, 80, 100, 125, 150

JUNTA MIRILLA PLANA

DIN 11850

Ref.8052



NW: 25, 32, 40, 50, 65, 80, 100, 125, 150

VALVULA NEUMATICA

Aisi 316L

Ref.SSV 200

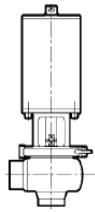

NW: 25, 32, 40, 50, 65, 80, 100

VALVULA NEUMATICA

Aisi 316L

Ref.SSV 300

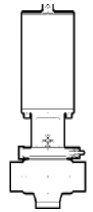

NW: 25, 32, 40, 50, 65, 80, 100

VALVULA NEUMATICA

Aisi 316L

Ref.SSV 210

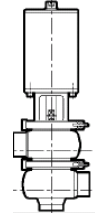

NW: 25, 32, 40, 50, 65, 80, 100

VALVULA NEUMATICA

Aisi 316L

Ref.SSV 220

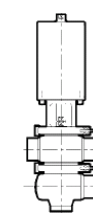

NW: 25, 32, 40, 50, 65, 80, 100

VALVULA NEUMATICA

Aisi 316L

Ref.SSV 310

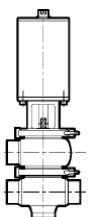

NW: 25, 32, 40, 50, 65, 80, 100

VALVULA NEUMATICA

Aisi 316L

Ref.SSV 320

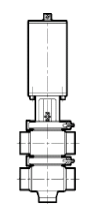

NW: 25, 32, 40, 50, 65, 80, 100

RELLENA BARRICAS SEMI-AUTOMATICO

Acabado sobre pedido : NW , ENOLOGICO,BSP

DN 25, 32, 40

